

REDWAY

Your Reliable OEM/ODM Manufacturer for Lithium-ion Battery Pack

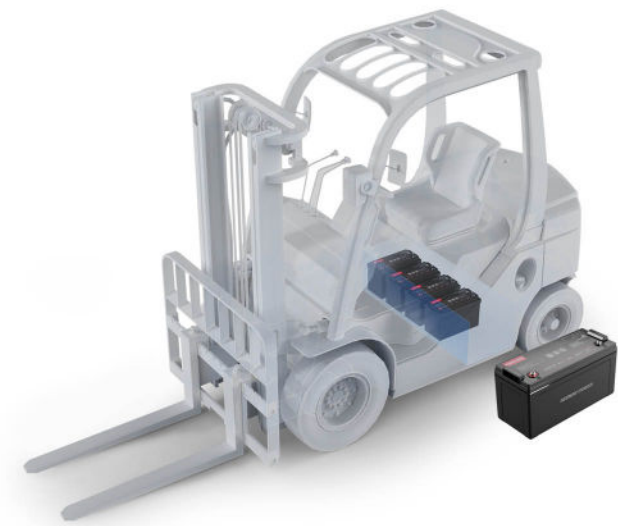

Sealed Lead Acid Replacement
Lithium-ion Battery Pack Series
Catalogue



INTRODUCTION

Redway Battery 12V/24V/36V/48V/60V/72V/80V Lithium-ion Battery Series (LiFePO4 / NMC) is a high safety Lithium-ion Battery with high rates and energy density.

This 8000 times deep cycle lithium-ion battery can replace the normal lead acid type easily, featuring long service life, space efficiency and environmental friendly, widely used for **RV, Marine, Golf Carts, Sightseeing Car, Floor Cleaning Machine, Forklift, AGV, AMR, Electric Scooter, Power Wheelchair, Solar or On-Grid Energy Storage** and **Renewable Energy** applications.



ADVANTAGES FOR RECREATIONAL VEHICLES

It's hard to beat a Redway lithium-ion battery when they deliver everything you need to support life on the road and off-the-grid. Inherently safe and lightweight, you'll not only travel further more efficiently, you'll do it with less of a footprint without sacrificing power, performance and reliability.



FEATURES AND BENEFITS



MORE USABLE CAPACITY

Lithium batteries allow you to use 100% of their capacity, regardless of the rate of discharge. So, run all your electronics and know that you have ample reserves, even when you're boondocking.



LONGER LIFE

Redway lithium batteries provide up to 10 times longer life than lead-acid batteries, and they still provide 80% of rated capacity after 4000 cycles.



INSTALLATION FLEXIBILITY

Can be installed upright or on its side.

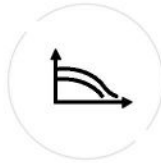

CONSTANT POWER

Full power available throughout discharge. Voltage does not drop like lead-acid.



LIGHTER WEIGHT

50-60% less weight than lead-acid equivalent.



MAINTENANCE-FREE

Plug, play and charge. No watering.



TEMPERATURE TOLERANCE

2.5X more efficient operation at low temperatures. Safely operational up to 149°F (65°C).

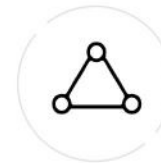

PARTIAL STATE OF CHARGE TOLERANCE

Partial charging does not affect performance quality or battery life. A low self-discharge rate means worryfree storage so even occasional users can be assured of reliable performance.



ECO-FRIENDLY & SAFE

Redway lithium batteries create no exhaust fumes so you can use them in a confined space with no ill effects. No gassing, no fumes, and no pollution.

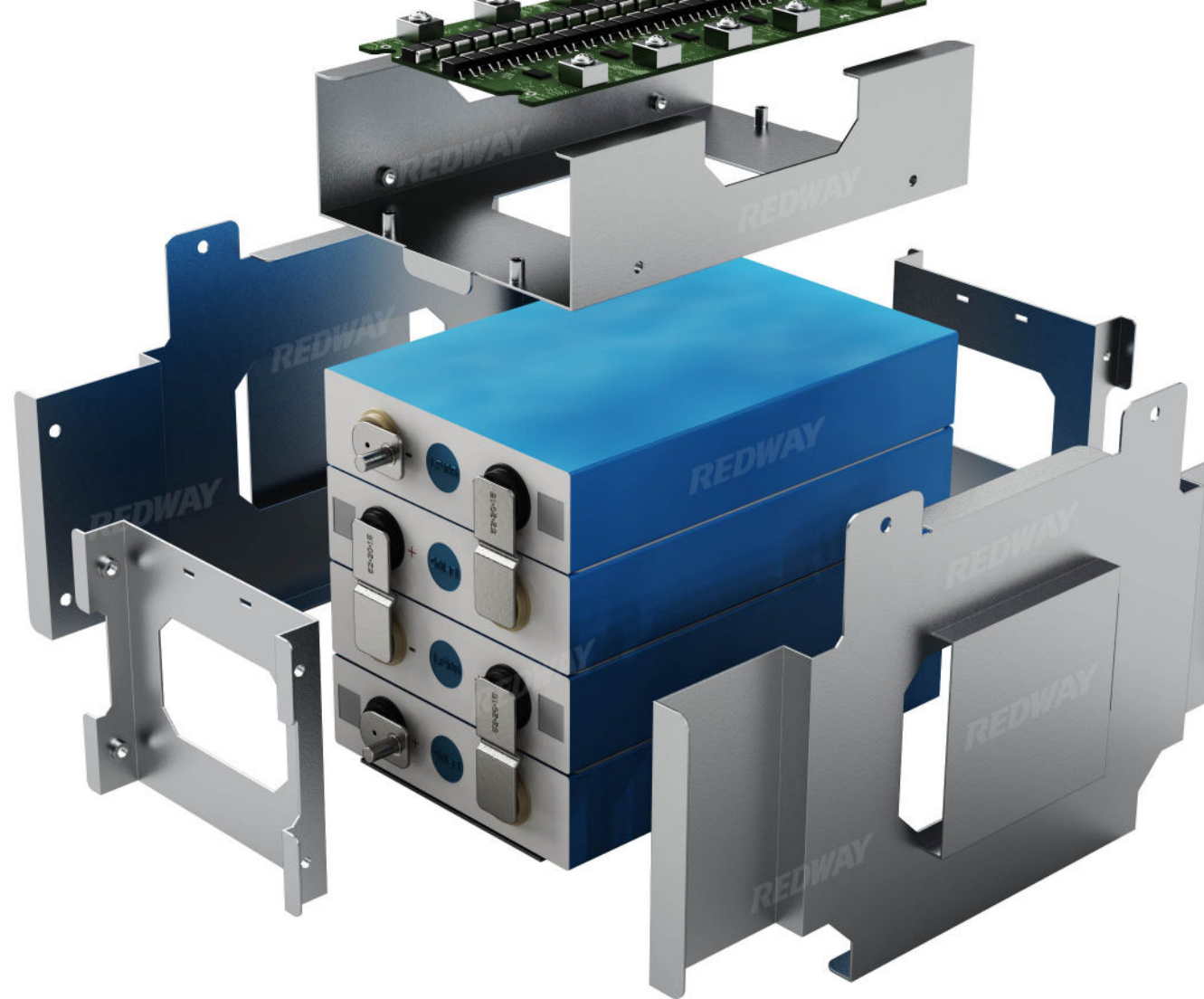

WHY NOT CHOOSE LEAD

Check out the chart below to compare the performance advantages of advanced lithium technology versus traditional lead-acid batteries.

BATTERY TYPE	FLA	AGM	LiFePO4
FEATURE			
Maintenance	High	Low	Zero
Life	2-4x	-	10-20x
Cost	0.5x	1x	4x
Sizes	Standard	Standard	Standard
Safe	Yes	Yes	Yes
Power	Declining	Declining	High & Constant
CHARGE			
Capacity	Partial	Partial	Full Rated
Charge Rate	Slow (10%)	Slow (20%)	Fast (100%)
Charge Time	Long	Long	Moderate (50%)
Charge Level	Full	Full	Partial/Full
Charge Frequency	Every Cycle	Every Cycle	Whenever
Partial State of Charge Tolerant	No	No	Yes



SPECIFICATIONS

12V

All series and other types can be customized according to customer needs

Model													
Cell Type	LiFePO4	LiFePO4	LiFePO4	LiFePO4	LiFePO4	LiFePO4	LiFePO4	LiFePO4	LiFePO4	LiFePO4	LiFePO4	LiFePO4	LiFePO4
Nominal Voltage	12.8 V	12.8 V	12.8 V	12.8 V	12.8 V	12.8 V	12.8 V	12.8 V	12.8 V	12.8 V	12.8 V	12.8 V	12.8 V
Nominal Capacity	6 Ah	12 Ah	18 Ah	24 Ah	30 Ah	50 Ah	54 Ah	75 Ah	100 Ah	105 Ah	105 Ah	105Ah	120 Ah
Nominal Energy	76.8 Wh	153.6 Wh	230.4 Wh	307.2 Wh	384 Wh	640 Wh	691.2 Wh	960 Wh	1280 Wh	1344 Wh	1344 Wh	1344 Wh	1536 Wh
Cycle Life (25°C @80% DOD)	> 6000 times	> 6000 times	> 6000 times	> 6000 times	> 6000 times	> 6000 times	> 6000 times	> 6000 times	> 6000 times	> 6000 times	> 6000 times	> 6000 times	> 6000 times
Protection Level	IP66	IP66	IP66	IP66	IP66	IP66	IP66	IP66	IP66	IP66	IP66	IP66	IP66
Dimension (L*W*H)	151 * 65 * 95 mm 5.94 * 2.56 * 3.74 in	151 * 98 * 97 mm 5.94 * 3.86 * 3.82 in	180 * 76 * 165 mm 7.09 * 2.99 * 6.5 in	177 * 167 * 124 mm 6.97 * 6.57 * 4.88 in	195 * 130 * 161 mm 7.68 * 5.12 * 6.34 in	198 * 166 * 170 mm 7.8 * 6.54 * 6.69 in	198 * 166 * 170 mm 7.8 * 6.54 * 6.69 in	260 * 168 * 210 mm 10.24 * 6.61 * 8.27 in	260 * 168 * 210 mm 10.24 * 6.61 * 8.27 in	330 * 172 * 215 mm 13 * 6.77 * 8.46 in	395 * 110 * 286 mm 15.55 * 4.33 * 11.26 in	276 * 174 * 189 mm 10.87 * 6.85 * 7.44 in	330 * 172 * 215 mm 13 * 6.77 * 8.46 in

Model													
Cell Type	LiFePO4	LiFePO4	LiFePO4	LiFePO4	LiFePO4	LiFePO4	LiFePO4	LiFePO4	LiFePO4	LiFePO4	LiFePO4	LiFePO4	LiFePO4
Nominal Voltage	12.8 V	12.8 V	12.8 V	12.8 V	12.8 V	12.8 V	12.8 V	12.8 V	12.8 V	12.8 V	12.8 V	12.8 V	12.8 V
Nominal Capacity	120 Ah	120 Ah	135 Ah	150 Ah	150 Ah	180 Ah	184 Ah	200 Ah	250 Ah	300 Ah	400 Ah	450 Ah	500 Ah
Nominal Energy	1536 Wh	1536 Wh	1728 Wh	1920 Wh	1920 Wh	2304 Wh	2355.2 Wh	2560 Wh	3200 Wh	3840 Wh	5120 Wh	5760 Wh	6400 Wh
Cycle Life (25°C @80% DOD)	> 6000 times	> 6000 times	> 6000 times	> 6000 times	> 6000 times	> 6000 times	> 6000 times	> 6000 times	> 6000 times	> 6000 times	> 6000 times	> 6000 times	> 6000 times
Protection Level	IP66	IP66	IP66	IP66	IP66	IP66	IP66	IP66	IP66	IP66	IP66	IP66	IP66
Dimension (L*W*H)	552 * 110 * 240 mm 21.73 * 4.33 * 9.45 in	318 * 176 * 187 mm 12.52 * 6.93 * 7.36 in	355*175*188 mm 13.98*6.89*7.4 in	501 * 185 * 242 mm 19.72 * 7.28 * 9.53 in	552 * 110 * 288 mm 21.73 * 4.33 * 11.34 in	580 * 132 * 242 mm 22.83 * 5.2 * 9.53 in	678 * 138 * 158 mm 26.69 * 5.43 * 6.22 in	501 * 185 * 242 mm 19.72 * 7.28 * 9.53 in	522 * 240 * 218 mm 20.55 * 9.45 * 8.58 in	523 * 269 * 218 mm 20.59 * 10.59 * 8.58 in	520 * 269 * 220 mm 20.47 * 10.59 * 8.66 in	640 * 245 * 220 mm 25.2 * 9.6 * 8.7 in	524 * 220 * 467 mm 20.62 * 8.66 * 18.38 in



SPECIFICATIONS

24V

All series and other types can be customized according to customer needs

Model													
24V50Ah	24V60Ah	24V80Ah	24V100Ah	24V105Ah	24V105Ah-EU	24V150Ah	24V160Ah	24V184Ah-M (Steel)	24V200Ah	24V280Ah	24V300Ah	24V315Ah	
Cell Type	LiFePO4	LiFePO4	LiFePO4	LiFePO4	LiFePO4	LiFePO4	LiFePO4	LiFePO4	LiFePO4	LiFePO4	LiFePO4	LiFePO4	LiFePO4
Nominal Voltage	25.6 V	25.6 V	25.6 V	25.6 V	25.6 V	25.6 V	25.6 V	25.6 V	25.6 V	25.6 V	25.6 V	25.6 V	25.6 V
Nominal Capacity	50 Ah	60 Ah	80 Ah	100 Ah	105 Ah	105 Ah	150 Ah	160 Ah	184 Ah	200 Ah	280 Ah	300 Ah	315 Ah
Nominal Energy	1280 Wh	1536 Wh	2048 Wh	2560 Wh	2688 Wh	2688 Wh	3840 Wh	4096 Wh	4710.4 Wh	5120 Wh	7168 Wh	7680 Wh	8064 Wh
Cycle Life (25°C @80% DOD)	> 6000 times	> 6000 times	> 6000 times	> 6000 times	> 6000 times	> 6000 times	> 6000 times	> 6000 times	> 6000 times	> 6000 times	> 6000 times	> 6000 times	> 6000 times
Protection Level	IP66	IP66	IP66	IP66	IP66	IP66	IP66	IP66	IP66	IP66	IP66	IP66	IP66
Dimension (L*W*H)	260 * 168 * 210 mm 10.24 * 6.61 * 8.27 in	330 * 172 * 215 mm 13 * 6.77 * 8.46 in	338 * 307 * 228 mm 13.30 * 12.08 * 8.97 in	522 * 240 * 218 mm 20.55 * 9.45 * 8.58 in	522 * 240 * 218 mm 20.55 * 9.45 * 8.58 in	552 * 110 * 288 mm 21.73 * 4.33 * 11.34 in	523 * 269 * 218 mm 20.59 * 10.59 * 8.58 in	400 * 330 * 260 mm 15.74 * 13 * 10.23 in	678 * 238 * 158 mm 26.69 * 9.37 * 6.22 in	523 * 269 * 218 mm 20.59 * 10.59 * 8.58 in	640 * 245 * 220 mm 25.2 * 9.64 * 8.66 in	450 * 260 * 245 mm 17.71 * 10.23 * 9.64 in	523 * 430 * 218 mm 20.6 * 16.92 * 8.58 in

36V

Model													
36V50Ah	36V100Ah	36V150Ah	36V200Ah	36V300Ah									
Cell Type	LiFePO4	LiFePO4	LiFePO4	LiFePO4	LiFePO4								
Nominal Voltage	38.4 V	38.4 V	38.4 V	38.4 V	38.4 V								
Nominal Capacity	50 Ah	100 Ah	150 Ah	200 Ah	300 Ah								
Nominal Energy	1920 Wh	3840 Wh	5760 Wh	7680 Wh	11520 Wh								
Cycle Life (25°C @80% DOD)	> 6000 times	> 6000 times	> 6000 times	> 6000 times	> 6000 times								
Protection Level	IP66	IP66	IP66	IP66	IP66								
Dimension (L*W*H)	480 * 170 * 240 mm 19.2 * 6.8 * 9.2 in	522 * 240 * 218 mm 20.55 * 9.44 * 8.58 in	521 * 238 * 218 mm 20.5 * 9.37 * 8.58 in	400 * 330 * 280 mm 15.74 * 13 * 11 in	513 * 235 * 204 mm 20.2 * 9.25 * 8 in								



SPECIFICATIONS

48V

All series and other your need types can be customized according to customer needs

Model													
Cell Type	LiFePO4	NMC	LiFePO4	LiFePO4	NMC	NMC	LiFePO4	LiFePO4	LiFePO4	LiFePO4	LiFePO4	LiFePO4	LiFePO4
Nominal Voltage	51.2 V	51.8 V	51.2 V	51.2 V	51.8 V	51.8 V	51.2 V	51.2 V	51.2 V	51.2 V	51.2 V	51.2 V	51.2 V
Nominal Capacity	30 Ah	48 Ah	50 Ah	100 Ah	100 Ah	100 Ah	105 Ah	150 Ah	160 Ah	184 Ah	200 Ah	250 Ah	280Ah
Nominal Energy	1536 Wh	2304 Wh	2560 Wh	5120 Wh	4800 Wh	4800 Wh	5376 Wh	7680 Wh	8192 Wh	9420 Wh	10240 Wh	12800 Wh	14336 Wh
Cycle Life (25°C @80% DOD)	> 6000 times	> 3000 times	> 6000 times	> 6000 times	> 3000 times	> 3000 times	> 6000 times	> 6000 times	> 6000 times	> 6000 times	> 6000 times	> 6000 times	> 6000 times
Protection Level	IP66	IP66	IP66	IP66	IP66	IP66	IP66	IP66	IP66	IP66	IP66	IP66	IP66
Dimension (L*W*H)	328 * 173 * 216 mm 12.9 * 6.8 * 8.5 in	406 * 190 * 197 mm 16 * 7.5 * 7.75 in	502 * 186 * 240 mm 19.76 * 7.32 * 9.45 in	523 * 269 * 218 mm 20.59 * 11 * 8.58 in	460 * 230 * 190 mm 18.1 * 9 * 7.48 in	382 * 212 * 135 mm 15 * 8.34 * 5.31 in	460 * 334 * 247 mm 18.1 * 13.15 * 9.72 in	522 * 240 * 218 mm 20.55 * 9.45 * 8.58 in	675 * 325 * 263 mm 26.57 * 12.8 * 10.35 in	678 * 238 * 283 mm 26.69 * 9.37 * 11.14 in	580 * 370 * 230 mm 22.83 * 14.56 * 9.1 in	580 * 375 * 250 mm 22.83 * 14.76 * 9.84 in	800 * 520 * 450 mm 31.5 * 20.5 * 17.7 in

60V

72V

80V

Model													
Cell Type	LiFePO4	NMC	LiFePO4	LiFePO4	NMC	LiFePO4	NMC	LiFePO4	LiFePO4	LiFePO4	LiFePO4	LiFePO4	
Nominal Voltage	64 V	62 V	64 V	64 V	74 V	73.6 V	74 V	73.6 V	73.6 V	73.6 V	83.2 V	83.2 V	
Nominal Capacity	50 Ah	60 Ah	100 Ah	200 Ah	20 Ah	50 Ah	65 Ah	100 Ah	160 Ah	400 Ah	200 Ah	400 Ah	
Nominal Energy	3200 Wh	3720 Wh	6400 Wh	12800 Wh	1480 Wh	3680 Wh	4810 Wh	7360 Wh	11760 Wh	29440 Wh	16640 Wh	33280 Wh	
Cycle Life (25°C @80% DOD)	> 6000 times	> 3000 times	> 6000 times	> 6000 times	> 3000 times	> 6000 times	> 3000 times	> 6000 times	> 6000 times	> 6000 times	> 6000 times	> 6000 times	
Protection Level	IP66	IP66	IP66	IP66	IP66	IP66	IP66	IP66	IP66	IP66	IP66	IP66	
Dimension (L*W*H)	265 * 200 * 180 mm 10.43 * 7.9 * 7.1 in	400 * 350 * 300 mm 15.74 * 13.77 * 11.8 in	324 * 172 * 221 mm 12.75 * 6.75 * 8.7 in	570 * 290 * 270 mm 22.44 * 11.4 * 10.62 in	265 * 150 * 180 mm 10.4 * 5.9 * 7 in	510 * 430 * 430 mm 20 * 16.92 * 16.92 in	310 * 380 * 204 mm 12.2 * 14.96 * 8 in	740 * 320 * 246 mm 29.13 * 13 * 9.68 in	650 * 350 * 250 mm 25.6 * 13.8 * 9.84 in	1066 * 990 * 537 mm 41.96 * 39 * 21.14 in	651 * 490 * 335 mm 25.63 * 19.3 * 13.2 in	998 * 633 * 719 mm 39.3 * 25 * 28.3 in	



DIMENSIONS

12V Series

All series and other types can be customized according to customer needs



12V150Ah

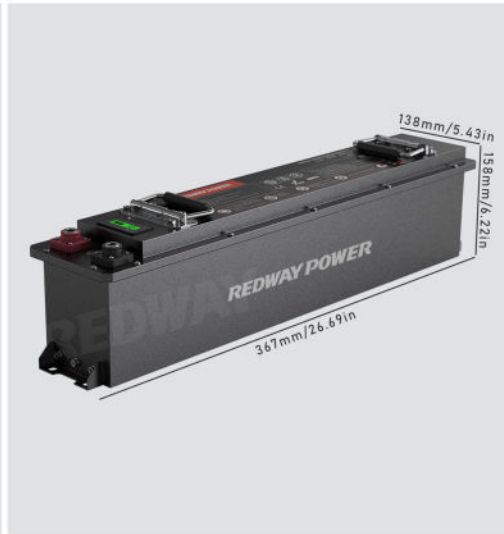

12V184Ah



12V200Ah



12V250Ah



12V300Ah



12V100Ah-EU



12V120Ah-EU



12V150Ah-EU



DIMENSIONS

24V Series

All series and other types can be customized according to customer needs



24V50Ah



24V60Ah



24V100Ah



24V150Ah



24V184Ah-M (Steel)



24V200Ah

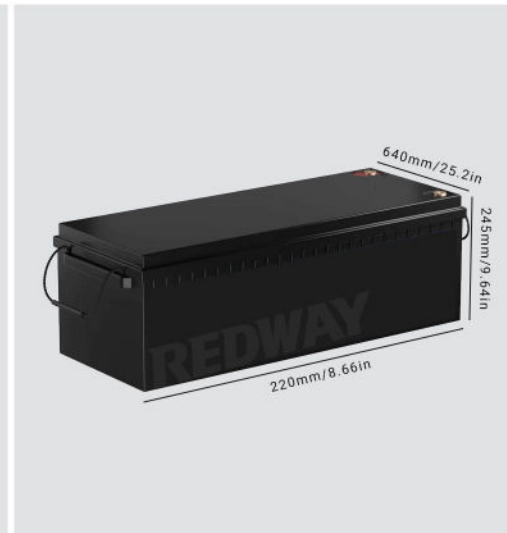

24V280Ah



24V300Ah



DIMENSIONS

36V / 48V Series

All series and other types can be customized according to customer needs



36V50Ah



36V60Ah



36V100Ah



36V150Ah



48V30Ah



48V50Ah



48V100Ah



48V200Ah



DIMENSIONS

60V / 72V Series

All series and other types can be customized according to customer needs



60V50Ah

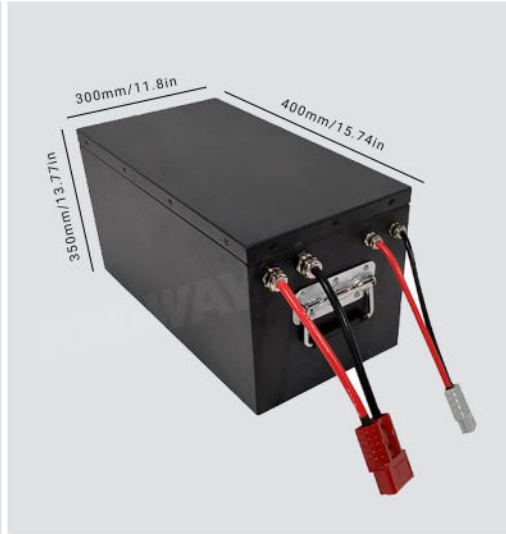

60V60Ah



60V100Ah



60V200Ah



72V20Ah



72V50Ah



72V100Ah



72V400Ah





YOUR MOST TRUSTED PARTNER

Whether on water or on the road, delivering an optimal user experience is at the heart of Redway Power's business. It's why we are proud to be the world's leading supplier of products and integrated systems to the marine, RV, and Specialty Vehicle industries. Our broad portfolio of market leading brands in power management, digital control & monitoring, and networked devices are distributed globally to a diverse aftermarket and OEM customer base. Redway Power is driven, every day, to be the world's most trusted partner to the marine and mobile industries.

Redway Battery provides our customers with the highest quality and safest lithium products, in compliance with all regulatory standards.

©2023 Redway Power, Inc. All rights reserved. Redway Power is not liable for damages that may result from any information provided in or omitted from this publication, under any circumstances. Redway Power reserves the right to make adjustments to this publication at any time, without notice or obligation.





Certifications

Factory: ISO 9001:2015
Cell: IEC 62619 / UL 1642 / UN38.3 / MSDS
Battery Pack: CE / IEC 62100 / RoHS / FCC
 (More available upon request)



ISO 9001:2015



UL

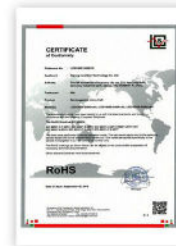

ROHS



UN 38.3



CE



IEC



OEM SERVICES



Inquiry

1. The experienced sales representatives will look at the submitted documents to evaluate the information provided.



Evaluation

2. Once we acquire all necessary info regarding your inquiry, our engineering department will develop the best solution based on your need.



Specification Verification

3. Engineers will send the best solution found to our sales representative and relay the information back to you to verify the solution provided.



Quotation

4. Once you verify the solution, we will formally send an estimated cost of service including any related fees to the fulfillment of the service.



Sample Production

5. Before moving to mass production, sample batteries will be provided to ensure customer satisfaction.



Price Verification

6. Once satisfied with the performance of samples and final design; a formal document of total price of services will be sent to you for final verification.



Production Schedule

7. Once the order has been paid, a timeframe of the production will be relayed to you by your sales representatives.



Shipment

8. Batteries will be shipped to the customer's designated location.

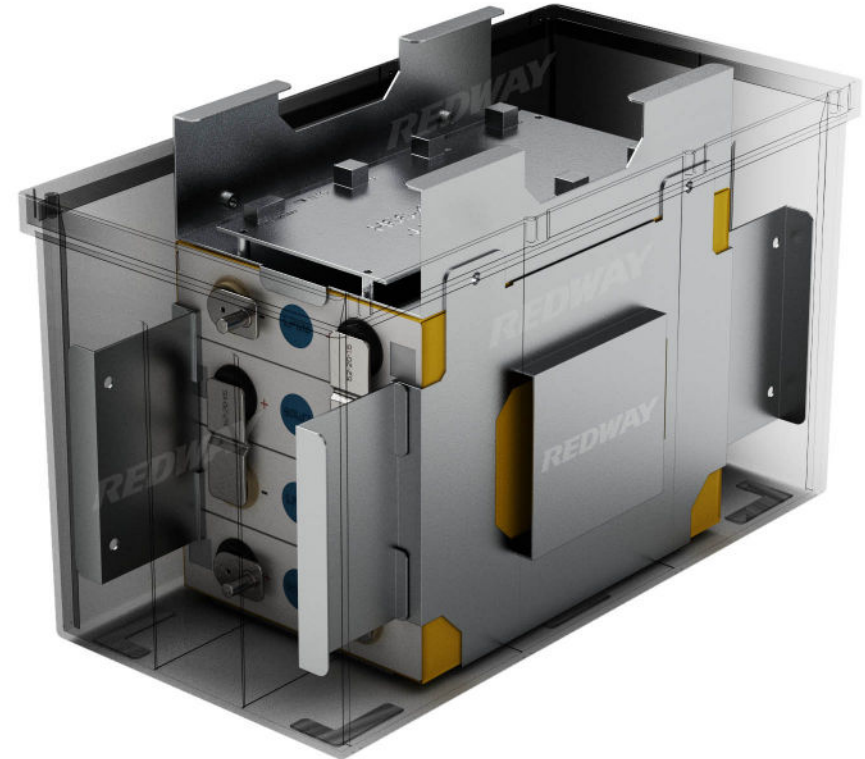

CAPABILITIES

- (1) Custom Manufacturing Capability
- (2) Ultrasonic Welding
- (3) Resistance Welding
- (4) Capacitance Discharge Welding
- (5) Custom Cable Assemblies
- (6) Small/Large Volume Capability
- (7) Prototyping Capability
- (8) Circuit Board Design (Battery Related)
- (9) Contract Manufacturing (Battery Related Devices)
- (10) In-House Design Capabilities (CAD)

ADVANTAGES

- (1) Assembly Solutions
- (2) Molded Plastic Cases
- (3) ISO 9001:2015 Certified
- (4) Computerized Milling Machines
- (5) In-House Engineering
- (6) Reverse Engineering
- (7) DFM Review
- (8) Solutions Oriented Sales Staff
- (9) Technical Advice and Follow-Up
- (10) Post Initial Order from Engineering, R&D and Sales to Ensure Quality and Performance





Redway Power Battery Group

Shenzhen Redway Power, Inc

Address: Building B, Huanzhi Center, Longhua District, Shenzhen

China Tel: +86 755 28010506

U.S Tel: +1 (650) 681 9800

E-mail: contact@redwaybattery.com

Website: <https://www.redwaybattery.com>

LinkedIn: @Redway Power Battery Group



WhatsApp



Shenzhen Redway Power, Inc

Building B, Huanzhi Center, Longhua District, Shenzhen



Redway Power Group (HK) Limited

FLAT/RM 7022 BLK D 7/F TAK WING INDUSTRY BLDG, 3 TSUN WEN ROAD TUEN MUN NT, HONG KONG



Hong Kong Rayworld Industrial Co., Limited

RM 21 UNIT A 11/F TIN WUI IND BLDG NO 3 HING WONG ST TUEN MUN NT, HONG KONG



Production Base 1 (Factory 1)

Building 2, 78 Puxing East Road, Qingxi Town, Dongguan



Production Base 2 (Factory 2)

No. 6 Xinyuan Road, Yantan District, Zigong, Sichuan



R&D Center

Building 5, No.105 Qingbin East Road, Qingxi Town, Dongguan